

# JVC



**CD RECEIVER**

**KD-AR260/KD-G210**

ENGLISH

**RECEPTOR CON CD**

**KD-AR260/KD-G210**

ESPAÑOL

**RECEPTEUR CD**

**KD-AR260/KD-G210**

FRANÇAIS

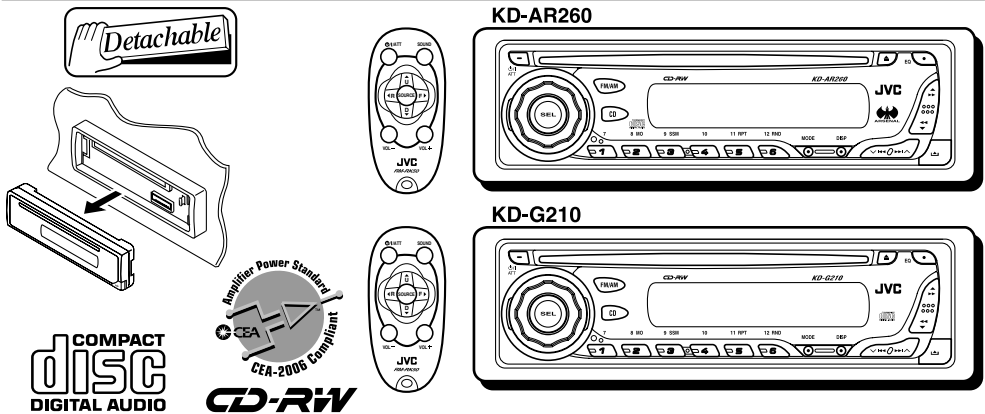

- This unit is equipped with the display demonstration. To cancel it, see page 8.
- Esta unidad está equipada con demostración en la pantalla. Para cancelarla, consulte la página 8.
- Cet appareil est équipé d'une fonction de démonstration des affichages. Pour l'annuler, référez-vous à la page 8.

For installation and connections, refer to the separate manual.  
Para la instalación y las conexiones, refiérase al manual separado.  
Pour l'installation et les raccordements, se référer au manuel séparé.

## **INSTRUCTIONS**

**MANUAL DE INSTRUCCIONES**  
**MANUEL D'INSTRUCTIONS**

**For customer Use:**  
Enter below the Model No. and Serial No. which are located on the top or bottom of the cabinet. Retain this information for future reference.

Model No. \_\_\_\_\_  
Serial No. \_\_\_\_\_

GET0246-001A

[J]



**INFORMATION (For U.S.A.)**

This equipment has been tested and found to comply with the limits for a Class B digital device, pursuant to Part 15 of the FCC Rules. These limits are designed to provide reasonable protection against harmful interference in a residential installation. This equipment generates, uses, and can radiate radio frequency energy and, if not installed and used in accordance with the instructions, may cause harmful interference to radio communications. However, there is no guarantee that interference will not occur in a particular installation. If this equipment does cause harmful interference to radio or television reception, which can be determined by turning the equipment off and on, the user is encouraged to try to correct the interference by one or more of the following measures:

- Reorient or relocate the receiving antenna.
- Increase the separation between the equipment and receiver.
- Connect the equipment into an outlet on a circuit different from that to which the receiver is connected.
- Consult the dealer or an experienced radio/TV technician for help.

**IMPORTANT FOR LASER PRODUCTS**

1. CLASS 1 LASER PRODUCT
2. **CAUTION:** Do not open the top cover. There are no user serviceable parts inside the unit; leave all servicing to qualified service personnel.
3. **CAUTION:** Visible and invisible laser radiation when open and interlock failed or defeated. Avoid direct exposure to beam.

**Warning:**

*If you need to operate the receiver while driving, be sure to look ahead carefully or you may be involved in a traffic accident.*

**How to reset your receiver**

Press and hold both buttons at the same time.



- This will reset the microcomputer. Your preset adjustments will also be erased.
- If a disc is loaded, it will eject. Be careful not to drop the disc.

**How to forcibly eject a disc**

If a disc cannot be recognized by the receiver or cannot be ejected, ejects the disc as follows.

Press and hold both buttons at the same time.



- If this does not work, try to reset your receiver.
- Be careful not to drop the disc when it ejects.

Thank you for purchasing a JVC product. Please read all instructions carefully before operation, to ensure your complete understanding and to obtain the best possible performance from the unit.

# CONTENTS

How to reset your receiver .....	2	Locating a track or a particular portion on a CD .....	15
How to forcibly eject a disc .....	2	Selecting CD playback modes .....	15
How to use the MODE button .....	3	Prohibiting CD ejection .....	16
<b>LOCATION OF THE BUTTONS .....</b>	<b>4</b>	<b>SOUND ADJUSTMENTS .....</b>	<b>17</b>
Control panel .....	4	Selecting preset sound modes (C-EQ: custom equalizer) .....	17
Remote controller .....	5	Adjusting the sound .....	18
Preparing the remote controller .....	6	<b>OTHER MAIN FUNCTIONS .....</b>	<b>19</b>
<b>BASIC OPERATIONS .....</b>	<b>7</b>	Selecting the dimmer mode .....	19
Turning on the power .....	7	Selecting the amplifier gain control .....	19
Canceling the display demonstration .....	8	Detaching the control panel .....	20
Setting the clock .....	9	<b>TROUBLESHOOTING .....</b>	<b>21</b>
<b>RADIO OPERATIONS .....</b>	<b>10</b>	<b>MAINTENANCE .....</b>	<b>22</b>
Listening to the radio .....	10	Handling discs .....	22
Storing stations in memory .....	12	<b>SPECIFICATIONS .....</b>	<b>23</b>
Tuning in to a preset station .....	13		
<b>CD OPERATIONS .....</b>	<b>14</b>		
Playing a CD .....	14		

## How to use the MODE button

If you press MODE, the unit goes into functions mode, then the number buttons work as different function buttons.

Ex.: When number button 2 works as MO (monaural) button.

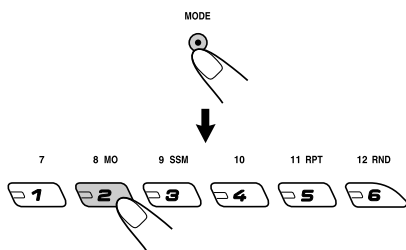

Time countdown indicator

To use these buttons for original functions again after pressing MODE, wait for 5 seconds without pressing any of these buttons until the functions mode is cleared.

- Pressing MODE again also clears the functions mode.

## BEFORE USE

### \*For safety...

- Do not raise the volume level too much, as this will block outside sounds, making driving dangerous.
- Stop the car before performing any complicated operations.

### \*Temperature inside the car...

If you have parked the car for a long time in hot or cold weather, wait until the temperature in the car becomes normal before operating the unit.



# LOCATION OF THE BUTTONS

ENGLISH

## Control panel

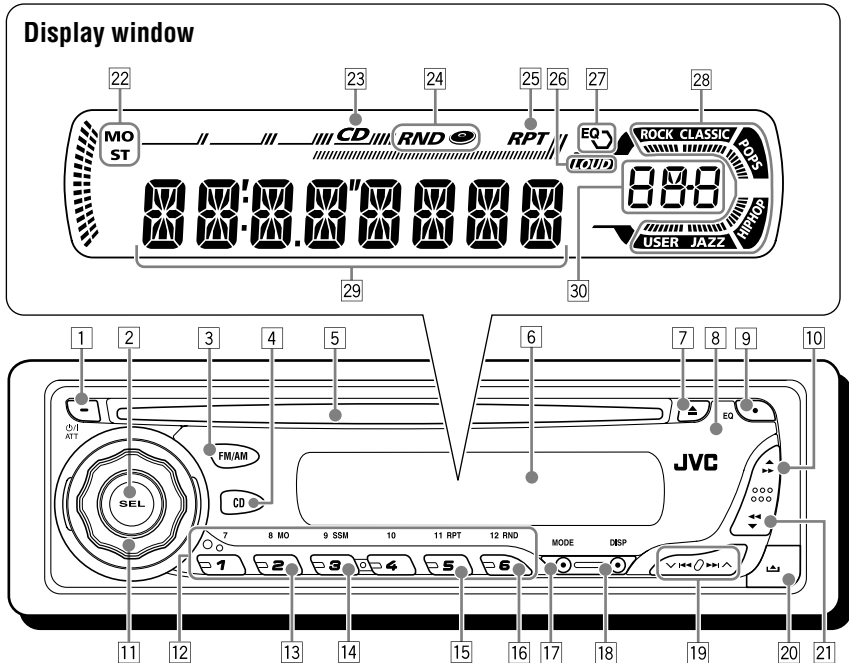

- 1  $\phi$ /I ATT (standby/on attenuator) button
- 2 SEL (select) button
- 3 FM/AM button
- 4 CD button
- 5 Loading slot
- 6 Display window
- 7  $\blacktriangle$  (eject) button
- 8 Remote sensor
- 9 EQ (equalizer) button
- 10  $\blacktriangle$  (up) button
- 11 Control dial
- 12 Number buttons
- 13 MO (monaural) button
- 14 SSM (Strong-station Sequential Memory) button
- 15 RPT (repeat) button
- 16 RND (random) button
- 17 MODE button
- 18 DISP (display) button
- 19  $\blacktriangleleft$   $\blacktriangleright$   $\blacktriangleleft$   $\blacktriangleright$   $\blacktriangle$  buttons
- 20  $\blacktriangle$  (control panel release) button
- 21  $\blacktriangledown$  (down) button
- 22  $\blacktriangleleft$  (reverse) button

### Display window

- 22 Tuner reception indicators—MO (monaural), ST (stereo)
- 23 CD indicator
- 24 RND (random disc) indicator
- 25 RPT (repeat) indicator
- 26 LOUD (loudness) indicator
- 27 EQ (equalizer) indicator
- 28 Sound mode (C-EQ: custom equalizer) indicators—ROCK, CLASSIC, POPS, HIP HOP, JAZZ, USER
- 29 Main display
- 30 Source display  
Volume level indicator



## Remote controller

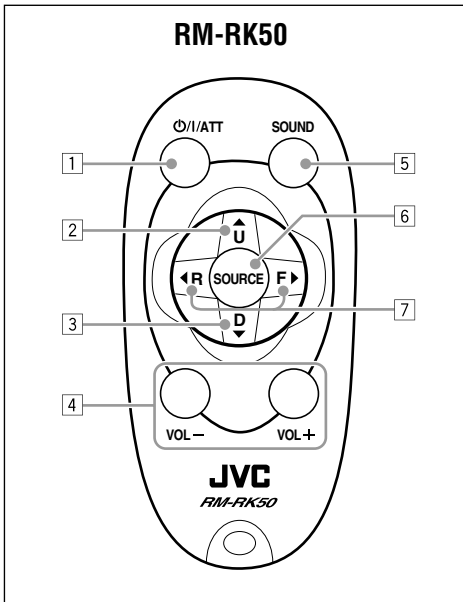

- 1 • Turns on the unit if pressed when the unit is turned off.
  - Turns off the unit if pressed and held until “SEE YOU” appears on the display.
  - Drops the volume level in a moment if pressed briefly.  
Press again to resume the volume.
- 2 Selects the band while listening to the radio.  
Each time you press the button, the band changes.
- 3 Selects the preset stations while listening to the radio.  
Each time you press the button, the preset station number increases, and the selected station is tuned in.

- 4 Functions the same as the control dial on the main unit.

**Note:** These buttons are not used for adjusting “DEMO”, “CLOCK H”, “CLOCK M”, “DIMMER”, and “AMP GAIN” (see pages 8, 9 and 19).

- 5 Selects the sound mode (C-EQ: custom equalizer).  
Each time you press the button, the sound mode (C-EQ) changes.
- 6 Selects the source.  
Each time you press the button, the source changes.
- 7 • Searches for stations while listening to the radio.
  - Fast-forwards or reverses the track if pressed and held while listening to a CD.
  - Skips to the beginning of the next track or goes back to the beginning of the current (or previous) tracks if pressed briefly while listening to a CD.

## Preparing the remote controller

Before using the remote controller:

- Aim the remote controller directly at the remote sensor on the main unit. Make sure there is no obstacle in between.

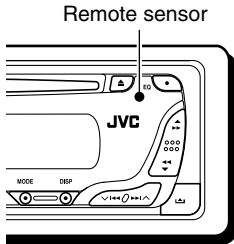

- Do not expose the remote sensor to strong light (direct sunlight or artificial lighting).

### Installing the battery

When the controllable range or effectiveness of the remote controller decreases, replace the battery.

#### 1. Remove the battery holder.

- 1) Push out the battery holder in the direction indicated by the arrow using a ball point pen or a similar tool.
- 2) Remove the battery holder.

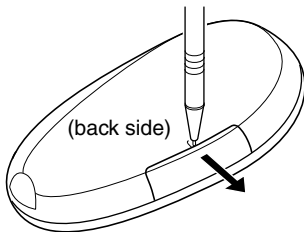

#### 2. Place the battery.

Slide the battery into the holder with the + side facing upwards so that the battery is fixed in the holder.

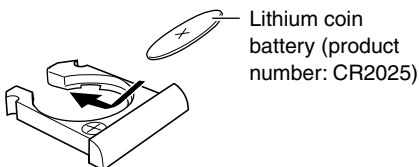

#### 3. Return the battery holder.

Insert again the battery holder by pushing it until you hear a clicking sound.

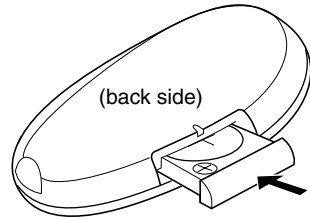

#### WARNING:

- Store the battery in a place which children cannot reach.  
*If a child accidentally swallows the battery, immediately consult a doctor.*
- Do not recharge, short, disassemble or heat the battery or dispose of in a fire.  
*Doing any of these things may cause the battery to give off heat, crack or start a fire.*
- Do not leave the battery with other metallic materials.  
*Doing this may cause the battery to give off heat, crack or start a fire.*
- When throwing away or saving the battery, wrap in tape and insulate; otherwise, it may cause the battery to give off heat, crack or start a fire.
- Do not poke the battery with tweezers or similar tools.  
*Doing this may cause the battery to give off heat, crack or start a fire.*

#### CAUTION:

**DO NOT** leave the remote controller in a place (such as dashboards) exposed to direct sunlight for a long time. Otherwise, it may be damaged.

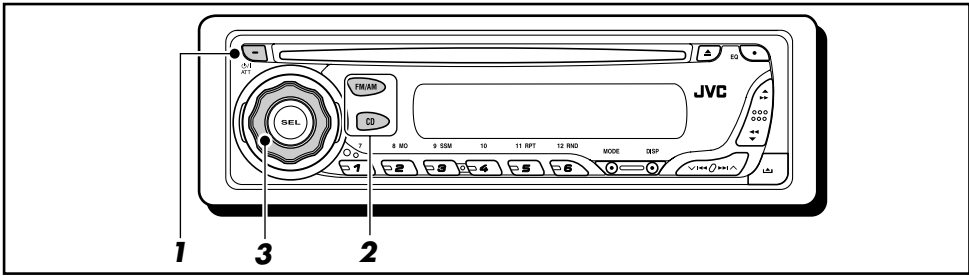

## Turning on the power

### 1 Turn on the power.



#### Note on One-Touch Operation:

When you select a source in step 2 below, the power automatically comes on. You do not have to press this button to turn on the power.

### 2 Select the source.

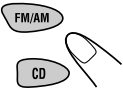

To operate the tuner (FM or AM),  
see pages 10 – 13.  
To play a CD,  
see pages 14 – 16.

### 3 Adjust the volume.

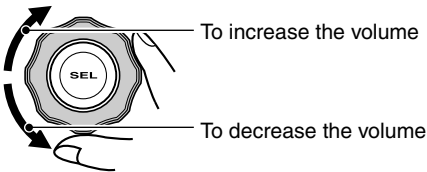

Volume level appears.

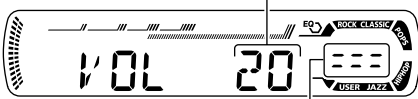

Volume level indicator

### 4 Adjust the sound as you want. (See pages 17 and 18.)

#### To drop the volume in a moment

Press  $\phi$ /I ATT briefly while listening to any source. "ATT" starts flashing on the display, and the volume level will drop in a moment.

To resume the previous volume level, press the button briefly again.

- If you turn the control dial, you can also restore the sound.

#### To turn off the power

Press and hold  $\phi$ /I ATT for more than one second.

"SEE YOU" appears, then the unit turns off.

- **If you turn off the power while listening to a CD,** CD play will start from where playback has been stopped previously, next time you turn on the power.

#### CAUTION on Volume Setting:

CDs produce very little noise compared with other sources. If the volume level is adjusted for the tuner, for example, the speakers may be damaged by the sudden increase in the output level. Therefore, lower the volume before playing a CD and adjust it as required during playback.

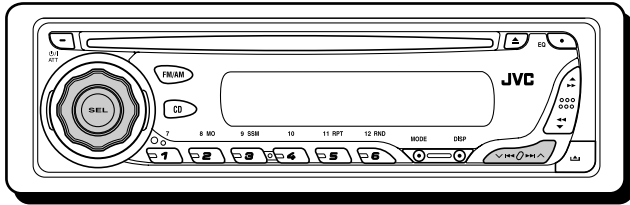

## Canceling the display demonstration

When shipped from the factory, display demonstration has been activated, and starts automatically when no operations are done for about 20 seconds.

- It is recommended to cancel the display demonstration before you use the unit for the first time.

To cancel the display demonstration, follow the procedure below:

### 1 Press and hold SEL (select) for more than 2 seconds.

“DEMO”, “CLOCK H”, “CLOCK M”, “DIMMER”, or “AMP GAIN” appears on the display.



### 2 Select “DEMO” if not shown on the display.

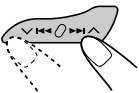

### 3 Select “DEMO OFF.”

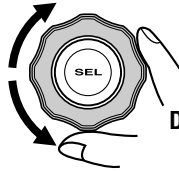

DEMO OFF ↔ DEMO ON



### 4 Finish the setting.



To activate the display demonstration, repeat the same procedure and select “DEMO ON” in step 3.



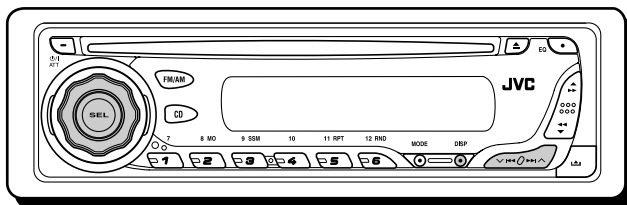

## Setting the clock

### 1 Press and hold SEL (select) for more than 2 seconds.

“DEMO”, “CLOCK H”, “CLOCK M”, “DIMMER”, or “AMP GAIN” appears on the display.



### 2 Set the hour.

- 1 Select “CLOCK H” (hour) if not shown on the display.
- 2 Adjust the hour.

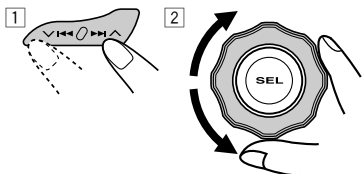

### 3 Set the minute.

- 1 Select “CLOCK M” (minute).
- 2 Adjust the minute.

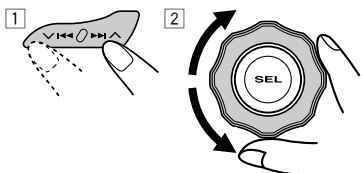

### 4 Finish the setting.



To check the current clock time or change the display mode



Press DISP (display) repeatedly. Each time you press the button, the display changes as follows:

- During tuner operation:

Frequency ↔ Clock

- During CD operation:

Elapsed playing time ↔ Clock

- During power off:

The power turns on and the clock time is shown for 5 seconds, then the power turns off.



# RADIO OPERATIONS

ENGLISH

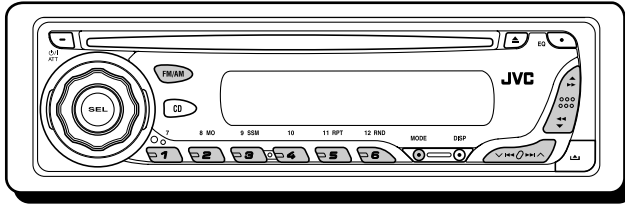

## Listening to the radio

You can use either automatic searching or manual searching to tune in to a particular station.

### Searching for a station automatically: Auto search

#### 1 Select the band (FM1 – 3, AM).



Each time you press the button, the band changes as follows:

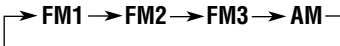

Lights up when receiving an FM stereo broadcast with sufficient signal strength.

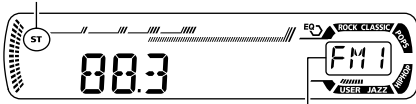

Selected band appears.

#### Note:

*This receiver has three FM bands (FM1, FM2, FM3). You can use any one of them to listen to an FM broadcast.*

#### 2 Start searching for a station.

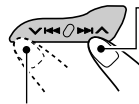

To search for stations of higher frequencies

To search for stations of lower frequencies

When a station is received, searching stops.

**To stop searching before a station is received,** press the same button you have pressed for searching.

## Searching for a station manually: Manual search

### 1 Select the band (FM1 – 3, AM).

Each time you press the button, the band changes as follows:

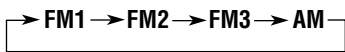

**Note:**

This receiver has three FM bands (FM1, FM2, FM3). You can use any one of them to listen to an FM broadcast.

### 2 Press and hold **▶▶** **▲** or **▼** **◀◀** until “M” (manual) starts flashing on the display.

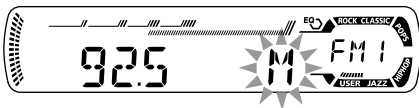
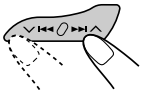

### 3 Tune in to a station you want while “M” (manual) is still flashing.

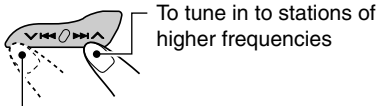

To tune in to stations of lower frequencies

- If you release your finger from the button, the manual mode will automatically turn off after 5 seconds.
- If you hold down the button, the frequency keeps changing (in 200 kHz intervals for FM and 10 kHz for AM) until you release the button.

## When an FM stereo broadcast is hard to receive

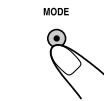

1 Press MODE to enter the functions mode while listening to an FM stereo broadcast.

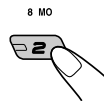

2 Press MO (monaural), while “MODE” is still flashing on the display, so that “MONO” appears on the display. Each time you press the button, monaural mode turns on and off alternately.

MO (monaural) indicator

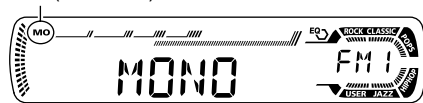

When the MO indicator is lit on the display, the sound you hear becomes monaural but the reception will be improved.



## Storing stations in memory

You can use one of the following two methods to store broadcasting stations in memory.

- Automatic preset of FM stations: SSM (Strong-station Sequential Memory)
- Manual preset of both FM and AM stations

### FM station automatic preset: SSM

You can preset 6 local FM stations in each FM band (FM1, FM2, and FM3).

#### 1 Select the FM band (FM1 – 3) you want to store FM stations into.



Each time you press the button, the band changes as follows:

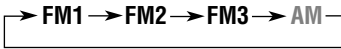

#### 2 Press MODE to enter the functions mode.

MODE



#### 3 Press and hold SSM for about 2 seconds.

9 SSM

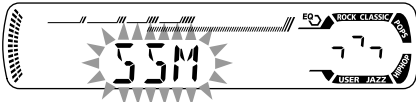
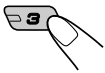

“SSM” flashes, then disappears when automatic preset is over.

Local FM stations with the strongest signals are searched and stored automatically in the band number you have selected (FM1, FM2, or FM3). These stations are preset in the number buttons—No.1 (lowest frequency) to No.6 (highest frequency).

When automatic preset is over, the station stored in number button 1 will be automatically tuned in.

## Manual preset

You can preset up to 6 stations in each band (FM1, FM2, FM3, and AM) manually.

Ex.: Storing FM station of 92.5 MHz into the preset number 1 of the FM1 band.

#### 1 Select the band (FM1 – 3, AM) you want to store stations into (in this example, FM1).



Each time you press the button, the band changes as follows:

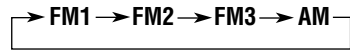

#### 2 Tune in to a station (in this example, of 92.5 MHz).



To tune in to stations of higher frequencies

To tune in to stations of lower frequencies

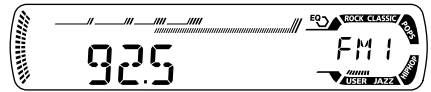

#### 3 Press and hold the number button (in this example, 1) for more than 2 seconds.

7

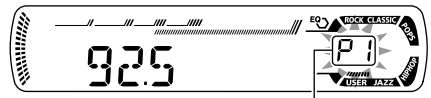

Preset number flashes for a while.

## 4 Repeat the above procedure to store other stations into other preset numbers.

### Notes:

- A previously preset station is erased when a new station is stored in the same preset number.
- Preset stations are erased when the power supply to the memory circuit is interrupted (for example, during battery replacement). If this occurs, preset the stations again.

## Tuning in to a preset station

You can easily tune in to a preset station. Remember that you must store stations first. If you have not stored them yet, see “Storing stations in memory” on pages 12 and 13.

### 1 Select the band (FM1 – 3, AM).



Each time you press the button, the band changes as follows:

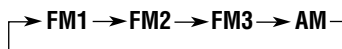

### 2 Select the number (1 – 6) for the preset station you want.

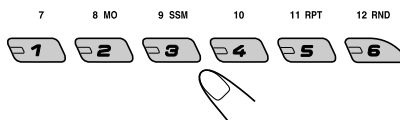

### Note:

You can also use the ▲ (up) or ▼ (down) button on the unit to select the next or previous preset stations. Each time you press the ▲ (up) or ▼ (down) button, the next or previous preset station is tuned in.



# CD OPERATIONS

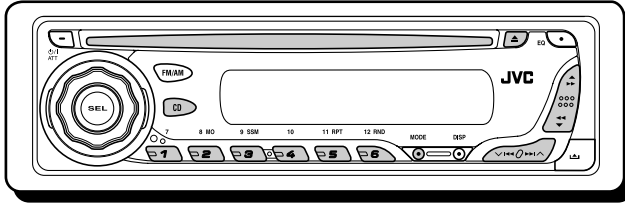

## Playing a CD

### Insert a CD into the loading slot.

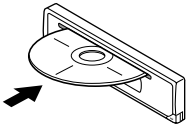

The unit turns on, draws the CD and starts playback automatically.

### Note on One-Touch Operation:

When a CD is already in the loading slot, pressing CD turns on the unit and starts playback automatically.

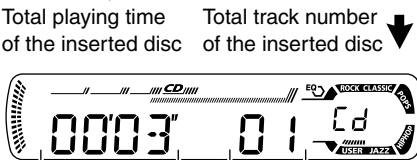
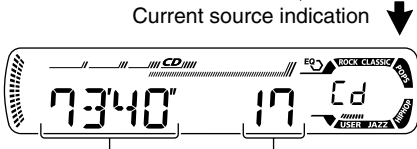
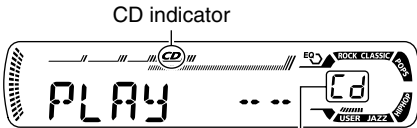

### Note:

When a CD is inserted upside down, "EJECT" appears on the display and the CD automatically ejects.

## To stop play and eject the CD

Press ▲.

CD play stops and the CD automatically ejects from the loading slot. The source changes to the tuner (you will hear the last received station.)

- If you change the source, CD play also stops (without ejecting the CD).

Next time you select "CD" as the source, CD play starts from where playback has been stopped previously.

### Notes:

- If the ejected CD is not removed for about 15 seconds, the CD is automatically inserted again into the loading slot to protect it from dust. (CD play will not start this time.)
- You can eject the CD even when the unit is turned off.

### About mistracking:

Mistracking may result from driving on extremely rough roads. This does not damage the unit and the CD, but will be annoying.

We recommend that you stop CD play while driving on such rough roads.

All tracks will be played repeatedly until you stop playback.



# Locating a track or a particular portion on a CD

## To fast-forward or reverse the track

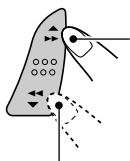

Press and hold ►►, while playing a CD, to fast-forward the track.

Press and hold ◀◀, while playing a CD, to reverse the track.

## To go to the next or previous tracks

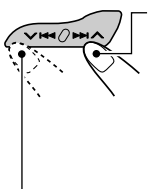

Press ►►|▲ briefly, while playing a CD, to go ahead to the beginning of the next track. Each time you press the button consecutively, the beginning of the next tracks is located and played back.

Press ▼◀◀ briefly, while playing a CD, to go back to the beginning of the current track. Each time you press the button consecutively, the beginning of the previous tracks is located and played back.

## To go to a particular track directly

Press the number button corresponding to the track number to start its playback.

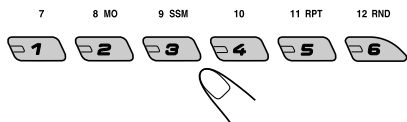

- To select a track number from 1 – 6:  
Press 1 (7) – 6 (12) briefly.
- To select a track number from 7 – 12:  
Press and hold 1 (7) – 6 (12) for more than one second.

# Selecting CD playback modes

## To play back tracks at random (Disc Random Play)

You can play back all tracks on the CD at random.



1 Press MODE to enter the functions mode while playing a CD.

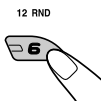

2 Press RND (random), while "MODE" is still flashing on the display, so that "DISC RND" appears on the display. Each time you press the button, disc random play mode turns on and off alternately.

RND (random disc) indicator

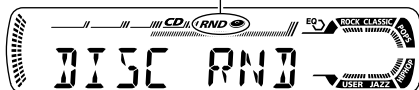

When disc random play is turned on, the RND indicator lights up on the display. A track randomly selected starts playing.



## To play back tracks repeatedly (Track Repeat Play)

You can play back the current track repeatedly.

MODE



- 1 Press MODE to enter the functions mode while playing a CD.

11 RPT



- 2 Press RPT (repeat), while "MODE" is still flashing on the display, so that "TRK RPT" appears on the display. Each time you press the button, track repeat play mode turns on and off alternately.

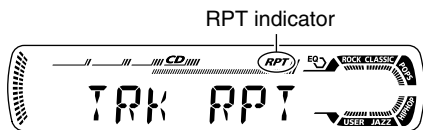

When track repeat play is turned on, the RPT indicator lights up on the display. The current track starts playing repeatedly.

## Prohibiting CD ejection

You can prohibit CD ejection and can lock a CD in the loading slot.

**While pressing CD, press and hold  $\blacktriangle$  for more than 2 seconds.**

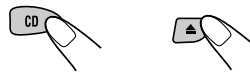

"NO EJECT" flashes on the display for about 5 seconds, and the CD is locked and cannot be ejected.



**To cancel the prohibition and unlock the CD**

While pressing CD, press and hold  $\blacktriangle$  again for more than 2 seconds.

"EJECT" appears on the display, and the CD ejects from the loading slot.







## Selecting preset sound modes (C-EQ: custom equalizer)

You can select a preset sound mode (C-EQ: custom equalizer) suitable to the music genre.

### Select the sound mode you want.

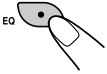

Each time you press the button, the sound modes change as follows:

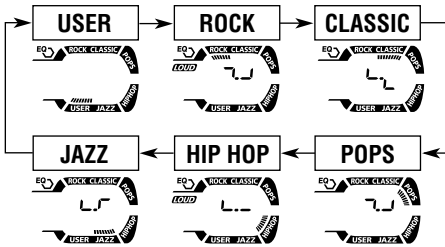

Indication pattern changes for each sound mode except for "USER."



Ex.: When you select "ROCK"

Indication	For:	Preset values		
		BAS	TRE	LOUD
USER	(Flat sound)	00	00	OFF
ROCK	Rock or disco music	+03	+01	ON
CLASSIC	Classical music	+01	-02	OFF
POPS	Light music	+04	+01	OFF
HIP HOP	Funk or rap music	+02	00	ON
JAZZ	Jazz music	+02	+03	OFF

### Note:

You can adjust each sound mode to your preference. Once you make an adjustment, it is automatically stored for the currently selected sound mode. See "Adjusting the sound" on page 18.



# Adjusting the sound

You can adjust the sound characteristics to your preference.

## 1 Select the item you want to adjust.



Each time you press the button, the adjustable items change as follows:

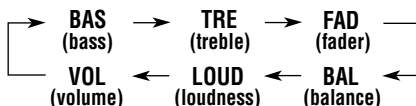

Indication	To do:	Range
BAS* <sup>1</sup>	Adjust the bass.	-06 (min.)   +06 (max.)
TRE* <sup>1</sup>	Adjust the treble.	-06 (min.)   +06 (max.)
FAD* <sup>2</sup>	Adjust the front and rear speaker balance.	R06 (Rear only)   F06 (Front only)
BAL	Adjust the left and right speaker balance.	L06 (Left only)   R06 (Right only)
LOUD* <sup>1</sup>	Boost low and high frequencies to produce a well-balanced sound at low volume level.	LOUD ON   LOUD OFF
VOL* <sup>3</sup>	Adjust the volume.	00 (min.)   30 or 50 (max.)* <sup>4</sup>

\*<sup>1</sup> When you adjust the bass, treble, or loudness, the adjustment you have made is stored for the currently selected sound mode (C-EQ) including "USER".

\*<sup>2</sup> If you are using a two-speaker system, set the fader level to "00".

\*<sup>3</sup> Normally the control dial works as the volume control. So you do not have to select "VOL" to adjust the volume level.

\*<sup>4</sup> Depending on the amplifier gain control setting. (See page 19 for details).

## 2 Adjust the setting.

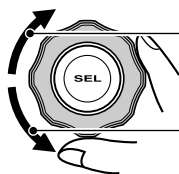

To increase the level or turn on the loudness

To decrease the level or turn off the loudness

Indication pattern changes as you adjust the bass or treble.

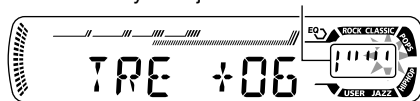

Ex. 1: When you adjust "TRE" (treble)



Ex. 2: When you turn on the loudness

## 3 Repeat steps 1 and 2 to adjust the other items.

To reset each sound mode to the factory settings, repeat the same procedure and reassign the preset values listed in the table on page 17.



## Selecting the dimmer mode

You can dim the display at night (according to your preference).

When shipped from the factory, dimmer is deactivated.

### 1 Press and hold SEL (select) for more than 2 seconds.

“DEMO”, “CLOCK H”, “CLOCK M”, “DIMMER”, or “AMP GAIN” appears on the display.



### 2 Select “DIMMER” if not shown on the display.



### 3 Select the desired mode—“OFF” or “ON.”

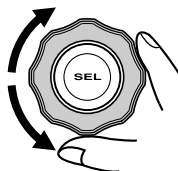

- OFF: Cancels the dimmer.
- ON: Activates the dimmer.

### 4 Finish the setting.



## Selecting the amplifier gain control

You can change the maximum volume level of this unit. When the maximum power of the speakers is less than 50 W, select “LOW PWR” to prevent them from being damaged.

When shipped from the factory, “HIGH PWR” is selected.

### 1 Press and hold SEL (select) for more than 2 seconds.

“DEMO”, “CLOCK H”, “CLOCK M”, “DIMMER”, or “AMP GAIN” appears on the display.



### 2 Select “AMP GAIN” if not shown on the display.

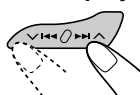

### 3 Select the desired mode—“HIGH PWR” or “LOW PWR”.

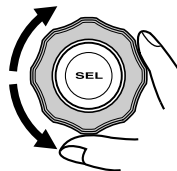

- LOW PWR: You can adjust the volume level from “VOL 00” to “VOL 30”.
- HIGH PWR: You can adjust the volume level from “VOL 00” to “VOL 50”.

### 4 Finish the setting.



**Note:**

If you change the setting from “HIGH PWR” to “LOW PWR” while listening at a volume level more than 30, the unit automatically changes the volume level to “VOL 30”.



## Detaching the control panel

You can detach the control panel when leaving the car.

When detaching or attaching the control panel, be careful not to damage the connectors on the back of the control panel and on the panel holder.

### Detaching the control panel

Before detaching the control panel, be sure to turn off the power.

#### 1 Unlock the control panel.

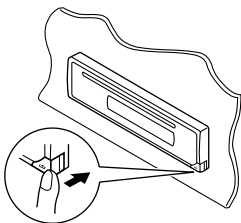

#### 2 Lift and pull the control panel out of the unit.

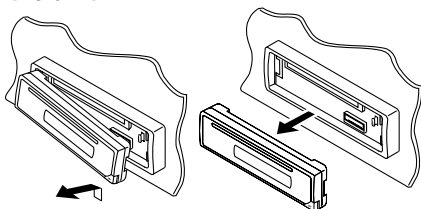

#### 3 Put the detached control panel into the provided case.

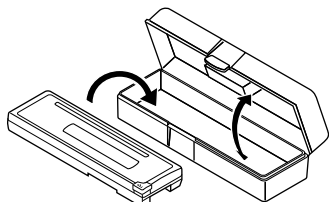

## Attaching the control panel

#### 1 Insert the left side of the control panel into the groove on the panel holder.

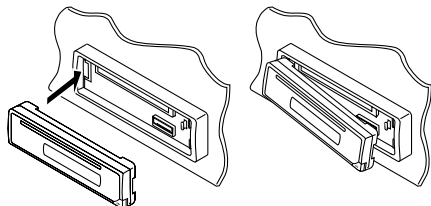

#### 2 Press the right side of the control panel to fix it to the panel holder.

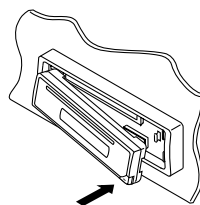

#### Note on cleaning the connectors:

If you frequently detach the control panel, the connectors will deteriorate. To minimize this possibility, periodically wipe the connectors with a cotton swab or cloth moistened with alcohol, being careful not to damage the connectors.

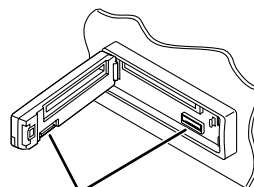

# TROUBLESHOOTING

What appears to be trouble is not always serious. Check the following points before calling a service center.

	Symptoms	Causes	Remedies
General	<ul style="list-style-type: none"> <li>Sound cannot be heard from the speakers.</li> </ul>	The volume level is set to the minimum level.	Adjust it to the optimum level.
		Connections are incorrect.	Check the cords and connections.
	<ul style="list-style-type: none"> <li>This unit does not work at all.</li> </ul>	The built-in microcomputer may have functioned incorrectly due to noise, etc.	While holding SEL (select), press $\phi$ /I ATT (standby/on attenuator) for more than 2 seconds to reset the unit. (Your preset adjustments will also be erased.) (See page 2.)
FM/AM	<ul style="list-style-type: none"> <li>SSM (Strong-station Sequential Memory) automatic preset does not work.</li> </ul>	Signals are too weak.	Store stations manually.
	<ul style="list-style-type: none"> <li>Static noise while listening to the radio.</li> </ul>	The antenna is not connected firmly.	Connect the antenna firmly.
CD Playback	<ul style="list-style-type: none"> <li>CD automatically ejects.</li> </ul>	CD is inserted upside down.	Insert the CD correctly.
	<ul style="list-style-type: none"> <li>CD-R/CD-RW cannot be played back.</li> <li>Tracks on the CD-R/CD-RW cannot be skipped.</li> </ul>	CD-R/CD-RW is not finalized.	<ul style="list-style-type: none"> <li>Insert a finalized CD-R/CD-RW.</li> <li>Finalize the CD-R/CD-RW with the component which you used for recording.</li> </ul>
		<ul style="list-style-type: none"> <li>CD can be neither played back nor ejected.</li> </ul>	CD is locked.
	The CD player may have functioned incorrectly.		While holding $\phi$ /I ATT (standby/on attenuator), press $\blacktriangle$ (eject) for more than 2 seconds. Be careful not to drop the CD when it is ejected.
	<ul style="list-style-type: none"> <li>CD sound is sometimes interrupted.</li> </ul>	You are driving on rough roads.	Stop playback while driving on rough roads.
		CD is scratched.	Change the CD.
		Connections are incorrect.	Check the cords and connections.
	<ul style="list-style-type: none"> <li>"NO DISC" appears on the display.</li> </ul>	No CD in the loading slot.	Insert a CD into the loading slot.
CD is inserted incorrectly.		Insert the CD correctly.	



# MAINTENANCE

ENGLISH

## Handling discs

This unit has been designed to reproduce CDs, CD-Rs (Recordable), and CD-RWs (Rewritable).

- **This unit is not compatible with MP3 discs.**

### How to handle discs

**When removing a disc from its case**, press down the center holder of the case and lift the disc out, holding it by the edges.

- Always hold the disc by the edges. Do not touch its recording surface.

**When storing a disc into its case**, gently insert the disc around the center holder (with the printed surface facing up).

- Make sure to store discs into the cases after use.

Center holder



### To keep discs clean

A dirty disc may not be played correctly. If a disc does become dirty, wipe it with a soft cloth in a straight line from center to edge.



### To play new discs

New discs may have some rough spots around the inner and outer edges. If such a disc is used, this unit may reject the disc.

To remove these rough spots, rub the edges with a pencil or ball-point pen, etc.



### Moisture condensation

Moisture may condense on the lens inside the CD player in the following cases:

- After starting the heater in the car.
- If it becomes very humid inside the car.

Should this occur, the CD player may malfunction. In this case, eject the disc and leave the unit turned on for a few hours until the moisture evaporates.

## When playing a CD-R or CD-RW

Before playing back CD-Rs or CD-RWs, read their instructions or cautions carefully.

- Use only "finalized" CD-Rs or CD-RWs.
- Some CD-Rs or CD-RWs may not be played back on this unit because of their disc characteristics, and for the following reasons:
  - Discs are dirty or scratched.
  - Moisture condensation on the lens inside the unit.
  - The pickup lens inside the unit is dirty.
- CD-RWs may require a longer readout time since the reflectance of CD-RWs is lower than that of regular CDs.
- CD-Rs or CD-RWs are susceptible to high temperatures or high humidity, so do not leave them inside your car.
- Do not use following CD-Rs or CD-RWs:
  - Discs with stickers, labels, or protective seal stuck to the surface.
  - Discs on which labels can be directly printed by an ink jet printer.

Using these discs under high temperatures or high humidity may cause malfunctions or damage to discs. For example,

- Stickers or labels may shrink and warp a disc.
- Stickers or labels may be peeled off so discs cannot be ejected.
- Print on discs may get sticky.

Read instructions or cautions about labels and printable discs carefully.

### CAUTIONS:

- Do not insert 8 cm (3 3/16") discs (single CDs) into the loading slot. (Such discs cannot be ejected.)
- Do not insert any disc of unusual shape—like a heart or flower; otherwise, it will cause a malfunction.
- Do not expose discs to direct sunlight or any heat source or place them in a place subject to high temperature and humidity. Do not leave them in a car.
- Do not use any solvent (for example, conventional record cleaner, spray, thinner, benzine, etc.) to clean discs.

Warped disc



Sticker



Sticker residue

Disc



Stick-on label

## AUDIO AMPLIFIER SECTION

### Power Output:

18 W RMS  $\times$  4 Channels at 4  $\Omega$   
and  $\leq$  1 % THD + N

### Signal to Noise Ratio:

80 dBA (reference: 1 W into 4  $\Omega$ )



Load Impedance: 4  $\Omega$  (4  $\Omega$  to 8  $\Omega$  allowance)

### Tone Control Range:

Bass:  $\pm$ 10 dB at 100 Hz

Treble:  $\pm$ 10 dB at 10 kHz

Frequency Response: 40 Hz to 20 000 Hz

### Line-Out Level/Impedance:

2.5 V/20 k $\Omega$  load (full scale)

Output Impedance: 1 k $\Omega$

## TUNER SECTION

### Frequency Range:

FM: 87.5 MHz to 107.9 MHz

AM: 530 kHz to 1 710 kHz

### [FM Tuner]

#### Usable Sensitivity:

11.3 dBf (1.0  $\mu$ V/75  $\Omega$ )

#### 50 dB Quieting Sensitivity:

16.3 dBf (1.8  $\mu$ V/75  $\Omega$ )

#### Alternate Channel Selectivity (400 kHz):

65 dB

Frequency Response: 40 Hz to 15 000 Hz

Stereo Separation: 35 dB

Capture Ratio: 1.5 dB

### [AM Tuner]

Sensitivity: 20  $\mu$ V

Selectivity: 35 dB

## CD PLAYER SECTION

Type: Compact disc player

Signal Detection System: Non-contact optical pickup (semiconductor laser)

Number of channels: 2 channels (stereo)

Frequency Response: 5 Hz to 20 000 Hz

Dynamic Range: 96 dB

Signal-to-Noise Ratio: 98 dB

Wow and Flutter: Less than measurable limit

## GENERAL

### Power Requirement:

#### Operating Voltage:

DC 14.4 V (11 V to 16 V allowance)

Grounding System: Negative ground

### Allowable Operating Temperature:

0°C to +40°C (32°F to 104°F)

### Dimensions (W $\times$ H $\times$ D):

#### Installation Size (approx.):

182 mm  $\times$  52 mm  $\times$  150 mm

(7-3/16"  $\times$  2-1/16"  $\times$  5-15/16")

#### Panel Size (approx.):

188 mm  $\times$  58 mm  $\times$  11 mm

(7-7/16"  $\times$  2-5/16"  $\times$  7/16")

#### Mass (approx.):

1.3 kg (2.9 lbs) (excluding accessories)

*Design and specifications are subject to change without notice.*

If a kit is necessary for your car, consult your telephone directory for the nearest car audio speciality shop.



**Having TROUBLE with operation?  
Please reset your unit**

Refer to page of How to Reset  
**Still having trouble??**

**USA ONLY**

**Call 1-800-252-5722**

**<http://www.jvc.com>**

**We can help you!**

**JVC**





# JVC KD-AR260/KD-G210

## Installation/Connection Manual Manual de instalación/conexión Manuel d'installation/raccordement

GET0246-002A  
[J]

0904DTSINTJEIN  
EN, SP, FR

### ENGLISH

This unit is designed to operate on **12 V DC, NEGATIVE ground electrical systems**. If your vehicle does not have this system, a voltage inverter is required, which can be purchased at JVC car audio dealers.

### ESPAÑOL

Esta unidad está diseñada para funcionar con **12 V de CC, con sistemas eléctricos de masa NEGATIVA**. Si su vehículo no posee este sistema, será necesario un inversor de tensión, que puede ser adquirido en los concesionarios de JVC de equipos de audio para automóviles.

### FRANÇAIS

Cet appareil est conçu pour fonctionner sur des sources de courant continu de **12 V à masse NEGATIVE**. Si votre véhicule n'offre pas ce type d'alimentation, il vous faut un convertisseur de tension, que vous pouvez acheter chez un revendeur d'autoradios JVC.

#### Parts list for installation and connection

The following parts are provided for this unit.  
After checking them, please set them correctly.

(A) / (B)  
Hard case/Control panel  
Estuche duro/Panel de control  
Etui de transport/Panneau de commande

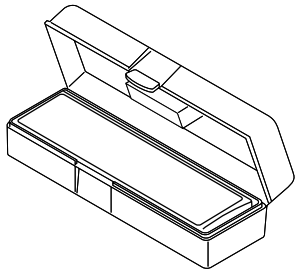

(C)  
Sleeve  
Cubierta  
Manchon

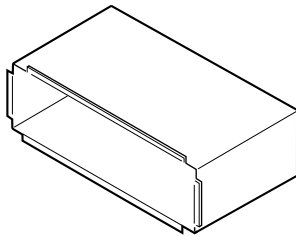

(D)  
Trim plate  
Placa de guarnición  
Plaque d'assemblage

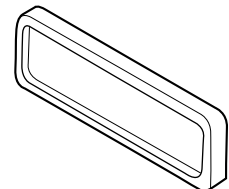

(E)  
Power cord  
Cordón de alimentación  
Cordon d'alimentation

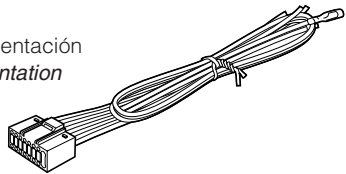

(F)  
Washer (ø5)  
Arandela (ø5)  
Rondelle (ø5)



(G)  
Lock nut (M5)  
Tuerca de seguridad (M5)  
Ecrou d'arrêt (M5)



(H)  
Mounting bolt (M5 x 20 mm)  
Perno de montaje (M5 x 20 mm)  
Boulon de montage (M5 x 20 mm)

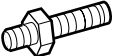

(I)  
Rubber cushion  
Cojín de goma  
Amortisseur en caoutchouc



(J)  
Handles  
Manijas  
Poignées

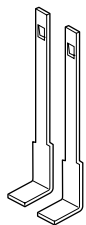

(K)  
Remote controller  
Mando a distancia  
Télécommande



(L)  
Battery  
Pila  
Pile



CR2025

## INSTALLATION (IN-DASH MOUNTING)

The following illustration shows a typical installation. If you have any questions or require information regarding installation kits, consult your JVC car audio dealer or a company supplying kits.

- If you are not sure how to install this unit correctly, have it installed by a qualified technician.

## INSTALACION (MONTAJE EN EL TABLERO DE INSTRUMENTOS)

La siguiente ilustración muestra una instalación típica. Si tiene alguna pregunta o necesita información acerca de las herramientas para instalación, consulte con su concesionario de JVC de equipos de audio para automóviles o a una compañía que suministra tales herramientas.

- Si usted no está seguro de cómo instalar correctamente la unidad, hágala instalar por un técnico cualificado.

## INSTALLATION (MONTAGE DANS LE TABLEAU DE BORD)

L'illustration suivante est un exemple d'installation typique. Si vous avez des questions ou avez besoin d'information sur des kits d'installation, consulter votre revendeur d'autoradios JVC ou une compagnie d'approvisionnement.

- Si l'on n'est pas sûr de pouvoir installer correctement cet appareil, le faire installer par un technicien qualifié.

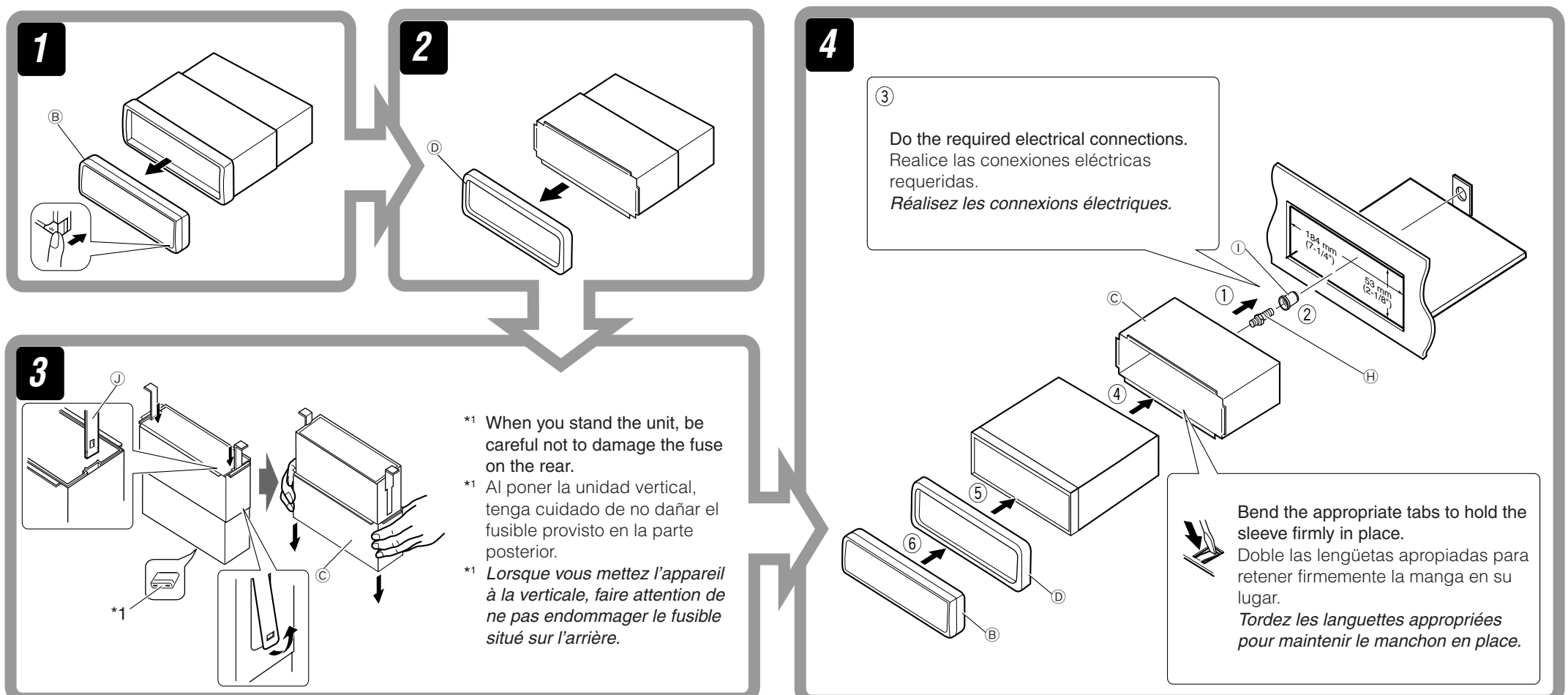

## Removing the unit

Before removing the unit, release the rear section.

## Extracción de la unidad

Antes de extraer la unidad, libere la sección trasera.

## Retrait de l'appareil

Avant de retirer l'appareil, libérer la section arrière.

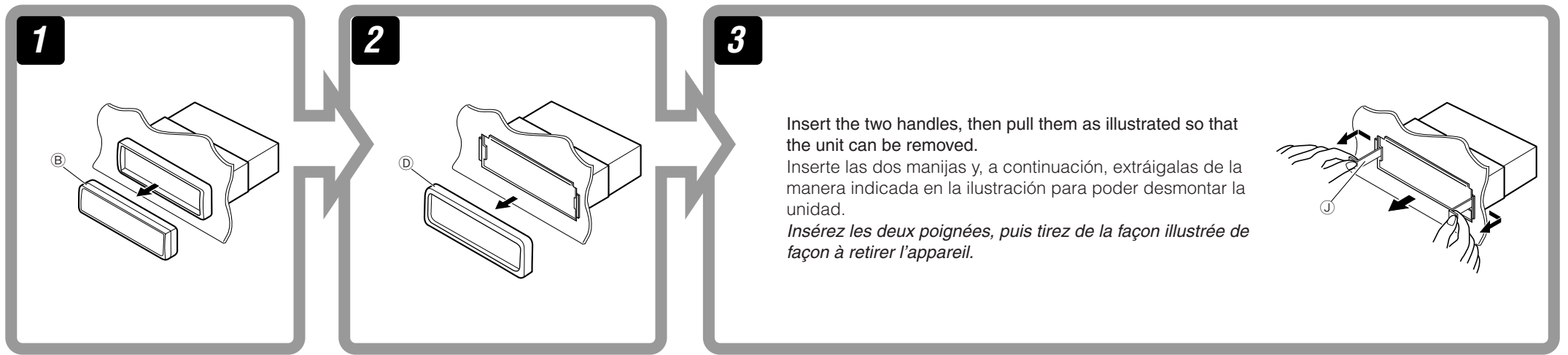

## When using the optional stay / Cuando emplea un soporte opcional / Lors de l'utilisation du hauban en option

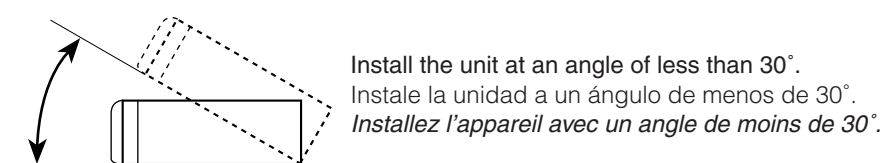
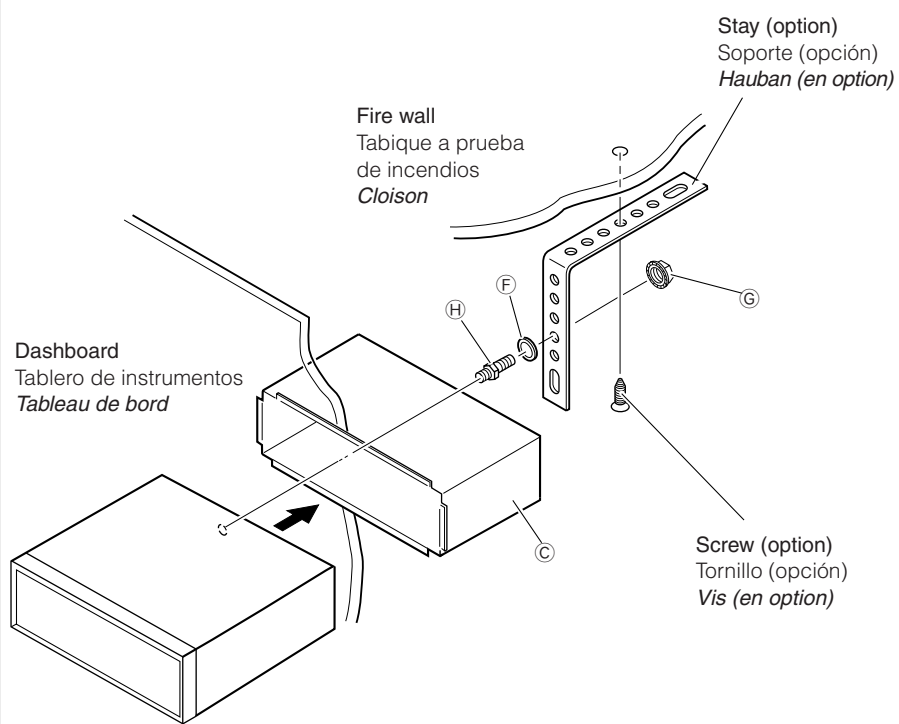

## When installing the unit without using the sleeve / Instalación de la unidad sin utilizar la manga / Lors de l'installation de l'appareil sans utiliser de manchon

In a Toyota for example, first remove the car radio and install the unit in its place.  
En un Toyota por ejemplo, primero retire la radio del automóvil y luego instale la unidad en su lugar.  
Par exemple dans une Toyota, retirer d'abord l'autoradio et installer l'appareil à la place.

Flat type screws—M5 x 8 mm (M5 x 3/8")\*  
Tornillos tipo plano—M5 x 8 mm (M5 x 3/8 pulgada)\*  
Vis à tête plate—M5 x 8 mm (M5 x 3/8 pouces)\*

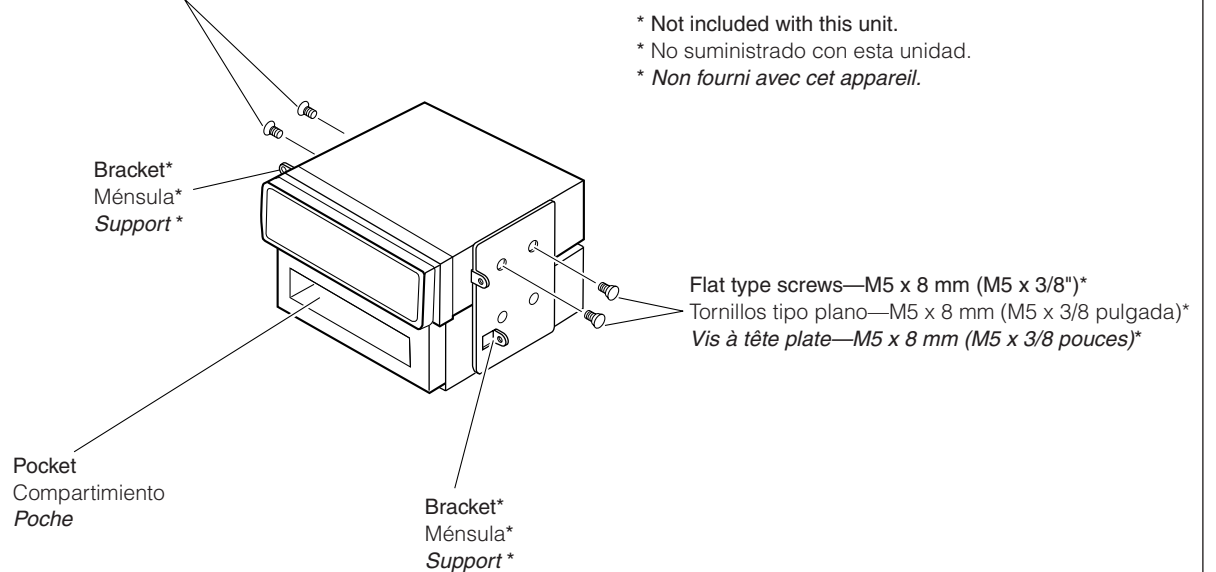

\* Not included with this unit.  
\* No suministrado con esta unidad.  
\* Non fourni avec cet appareil.

**Note** : When installing the unit on the mounting bracket, make sure to use the 8 mm (3/8")-long screws. If longer screws are used, they could damage the unit.  
**Nota** : Cuando instala la unidad en la ménsula de montaje, asegúrese de utilizar los tornillos de 8 mm (3/8 pulgada) de longitud. Si se utilizan tornillos más largos, éstos pueden dañar la unidad.  
**Remarque** : Lors de l'installation de l'appareil sur le support de montage, s'assurer d'utiliser des vis d'une longueur de 8 mm (3/8 pouces). Si des vis plus longues sont utilisées, elles peuvent endommager l'appareil.

## TROUBLESHOOTING

- **The fuse blows.**  
\* Are the red and black leads connected correctly?
- **Power cannot be turned on.**  
\* Is the yellow lead connected?
- **No sound from the speakers.**  
\* Is the speaker output lead short-circuited?
- **Sound is distorted.**  
\* Is the speaker output lead grounded?  
\* Are the “-” terminals of L and R speakers grounded in common?
- **Noise interfere with sounds.**  
\* Is the rear ground terminal connected to the car's chassis using shorter and thicker cords?
- **Unit becomes hot.**  
\* Is the speaker output lead grounded?  
\* Are the “-” terminals of L and R speakers grounded in common?
- **This receiver does not work at all.**  
\* Have you reset your receiver?

## LOCALIZACION DE AVERIAS

- **El fusible se quema.**  
\* ¿Están los conductores rojo y negro correctamente conectados?
- **No es posible conectar la alimentación.**  
\* ¿Está el cable amarillo conectado?
- **No sale sonido de los altavoces.**  
\* ¿Está el cable de salida del altavoz cortocircuitado?
- **El sonido presenta distorsión.**  
\* ¿Está el cable de salida del altavoz conectado a masa?  
\* ¿Están los terminales “-” de los altavoces L y R conectados a una masa común?
- **Perturbación de ruido.**  
\* ¿El terminal de tierra trasero está conectado al chasis del automóvil utilizando los cordones más corto y más grueso?
- **La unidad se calienta.**  
\* ¿Está el cable de salida del altavoz conectado a masa?  
\* ¿Están los terminales “-” de los altavoces L y R conectados a una masa común?
- **Este receptor no funciona en absoluto.**  
\* ¿Reinicializó el receptor?

## EN CAS DE DIFFICULTES

- **Le fusible saute.**  
\* Les fils rouge et noir sont-ils raccordés correctement?
- **L'appareil ne peut pas être mise sous tension.**  
\* Le fil jaune est-elle raccordée?
- **Pas de son des enceintes.**  
\* Le fil de sortie d'enceinte est-il court-circuité?
- **Le son est déformé.**  
\* Le fil de sortie d'enceinte est-il à la masse?  
\* Les bornes “-” des enceintes gauche et droit sont-elles mises ensemble à la masse?
- **Interférence avec les sons.**  
\* La prise arrière de mise à la terre est-elle connectée au châssis de la voiture avec un cordon court et épais?
- **L'appareil devient chaud.**  
\* Le fil de sortie d'enceinte est-il à la masse?  
\* Les bornes “-” des enceintes gauche et droit sont-elles mises ensemble à la masse?
- **Cet appareil ne fonctionne pas du tout.**  
\* Avez-vous réinitialisé votre appareil?

## ELECTRICAL CONNECTIONS

To prevent short circuits, we recommend that you disconnect the battery's negative terminal and make all electrical connections before installing the unit.

- **Be sure to ground this unit to the car's chassis again after installation.**

### Notes:

- Replace the fuse with one of the specified rating. If the fuse blows frequently, consult your JVC car audio dealer.
- It is recommended to connect to the speakers with maximum power of more than 50 W (both at the rear and at the front, with an impedance of 4 Ω to 8 Ω). If the maximum power is less than 50 W, change "AMP GAIN" setting to prevent the speakers from being damaged (see page 19 of the INSTRUCTIONS).
- To prevent short-circuit, cover the terminals of the UNUSED leads with insulating tape.
- The heat sink becomes very hot after use. Be careful not to touch it when removing this unit.

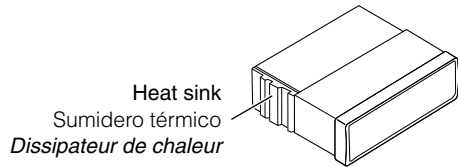

## CONEXIONES ELECTRICAS

Para evitar cortocircuitos, recomendamos que desconecte el terminal negativo de la batería y que efectúe todas las conexiones eléctricas antes de instalar la unidad.

- **Asegúrese de volver a conectar a masa esta unidad al chasis del automóvil después de la instalación.**

### Notas:

- Reemplace el fusible por uno con la corriente especificada. Si el fusible se quemase frecuentemente consulte con su concesionario de JVC de equipos de audio para automóviles.
- Se recomienda conectar los altavoces con una potencia máxima de más de 50 W (tanto atrás como adelante, con una impedancia de 4 Ω a 8 Ω). Si la potencia máxima es de menos de 50 W, cambie "AMP GAIN" para evitar daños en los altavoces (consulte la página 19 del MANUAL DE INSTRUCCIONES).
- Para evitar cortocircuitos, cubra los cables NO UTILIZADOS con cinta aislante.
- El sumidero térmico estará muy caliente después del uso. Asegúrese de no tocarlo al desmontar esta unidad.

## RACCORDEMENTS ELECTRIQUES

Pour éviter tout court-circuit, nous vous recommandons de débrancher la borne négative de la batterie et d'effectuer tous les raccordements électriques avant d'installer l'appareil.

- **Assurez-vous de raccorder de nouveau la mise à la masse de cet appareil au châssis de la voiture après l'installation.**

### Remarques:

- Remplacer le fusible par un de la valeur précisée. Si le fusible saute souvent, consulter votre revendeur d'autoradios JVC.
- Il est recommandé de connecter des enceintes avec une puissance de plus de 50 W (les enceintes arrière et les enceintes avant, avec une impédance comprise entre 4 Ω et 8 Ω). Si la puissance maximum est inférieure à 50 W, changez "AMP GAIN" pour éviter d'endommager vos enceintes (voir page 19 du MANUEL D'INSTRUCTIONS).
- Pour éviter les court-circuits, couvrir les bornes des fils qui ne sont PAS UTILISÉS avec de la bande isolante.
- Le dissipateur de chaleur devient très chaud après usage. Faire attention de ne pas le toucher en retirant cet appareil.

## A Typical Connections / Conexiones típicas / Raccordements typiques

**Before connecting:** Check the wiring in the vehicle carefully. Incorrect connection may cause serious damage to this unit. The leads of the power cord and those of the connector from the car body may be different in color.

- 1 Connect the colored leads of the power cord in the order specified in the illustration below.
- 2 Connect the antenna cord.
- 3 Finally connect the wiring harness to the unit.

**Antes de la conexión:** Verifique atentamente el conexionado del vehículo. Una conexión incorrecta podría producir daños graves en la unidad. Los cordones del cable de alimentación y los del conector procedentes de la carrocería del automóvil podrían ser de diferentes en color.

- 1 Conecte los conductores de color del cable de alimentación en el orden especificado en la ilustración de abajo.
- 2 Conecte el cable de antena.
- 3 Por último, conecte el cable de alimentación a la unidad.

**Avant de commencer la connexion:** Vérifiez attentivement le câblage du véhicule. Une connexion incorrecte peut endommager sérieusement l'appareil. Le fil du cordon d'alimentation et ceux des connecteurs du châssis de la voiture peuvent être différents en couleur.

- 1 Connectez les fils colorés du cordon d'alimentation dans l'ordre spécifié sur l'illustration ci-dessous.
- 2 Connectez le cordon d'antenne.
- 3 Finalement, connectez le faisceau de fils à l'appareil.

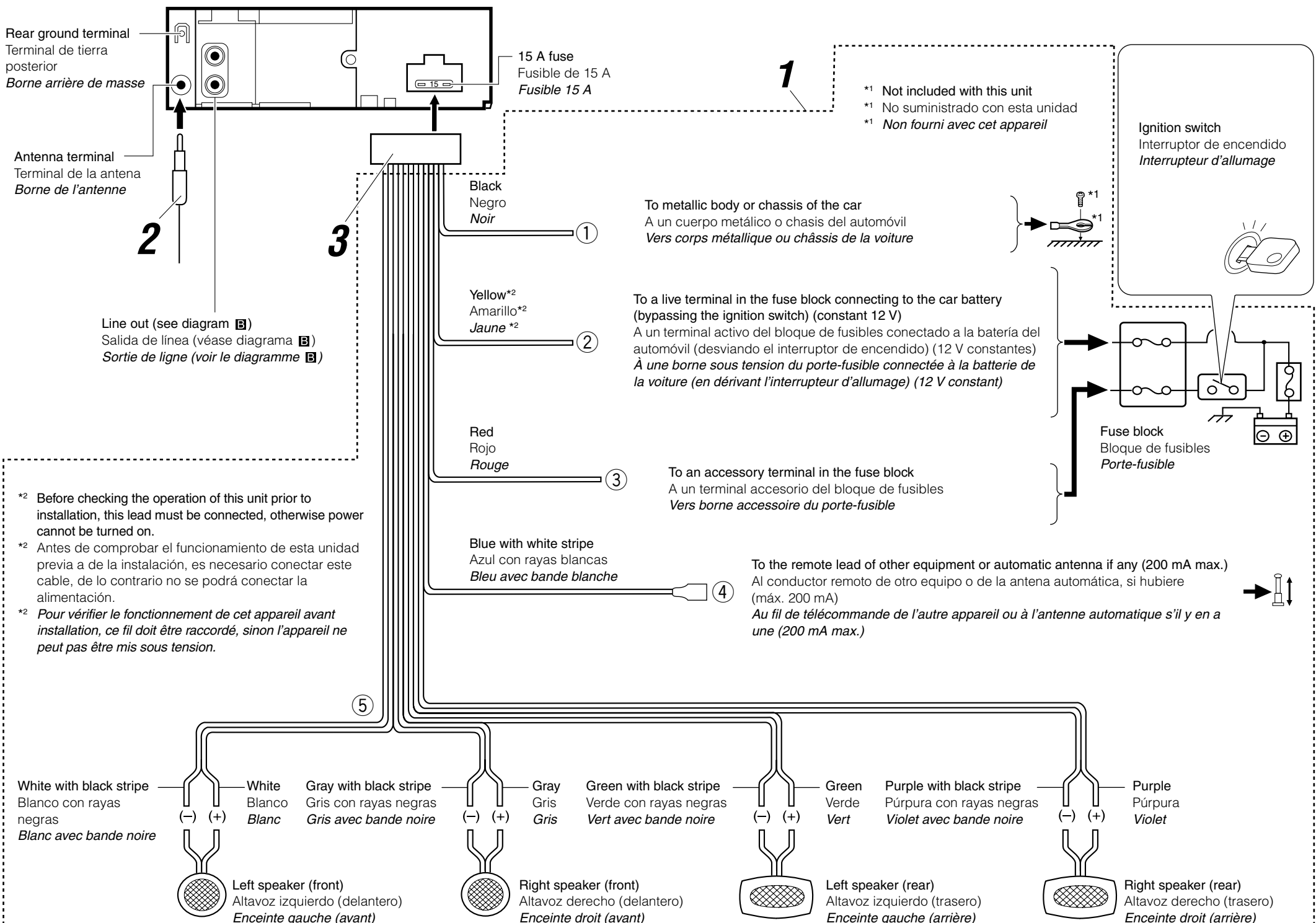

**Amplifier / Amplificador / Amplificateur**

You can connect an amplifier to upgrade your car stereo system.

- Connect the remote lead (blue with white stripe) to the remote lead of the other equipment so that it can be controlled through this unit.
- **Disconnect the speakers from this unit, connect them to the amplifier. Leave the speaker leads of this unit unused.**

Usted podrá conectar un amplificador para mejorar el sistema estéreo de su automóvil.

- Conecte el conductor remoto (azul con rayas blancas) al conductor remoto del otro equipo para poderlo controlar a través de esta unidad.
- **Desconecte los altavoces de esta unidad y conéctelos al amplificador. Los cables de los altavoces de esta unidad quedan sin usar.**

Vous pouvez connecter un amplificateur pour améliorer votre système autoradio.

- Connectez le fil de commande à distance (bleu avec bande blanche) au fil de commande à distance de l'autre appareil de façon qu'il puisse être commandé via cet appareil.
- **Déconnectez les enceintes de cet appareil et connectez-les à l'amplificateur. Laissez les fils d'enceintes de cet appareil inutilisés.**

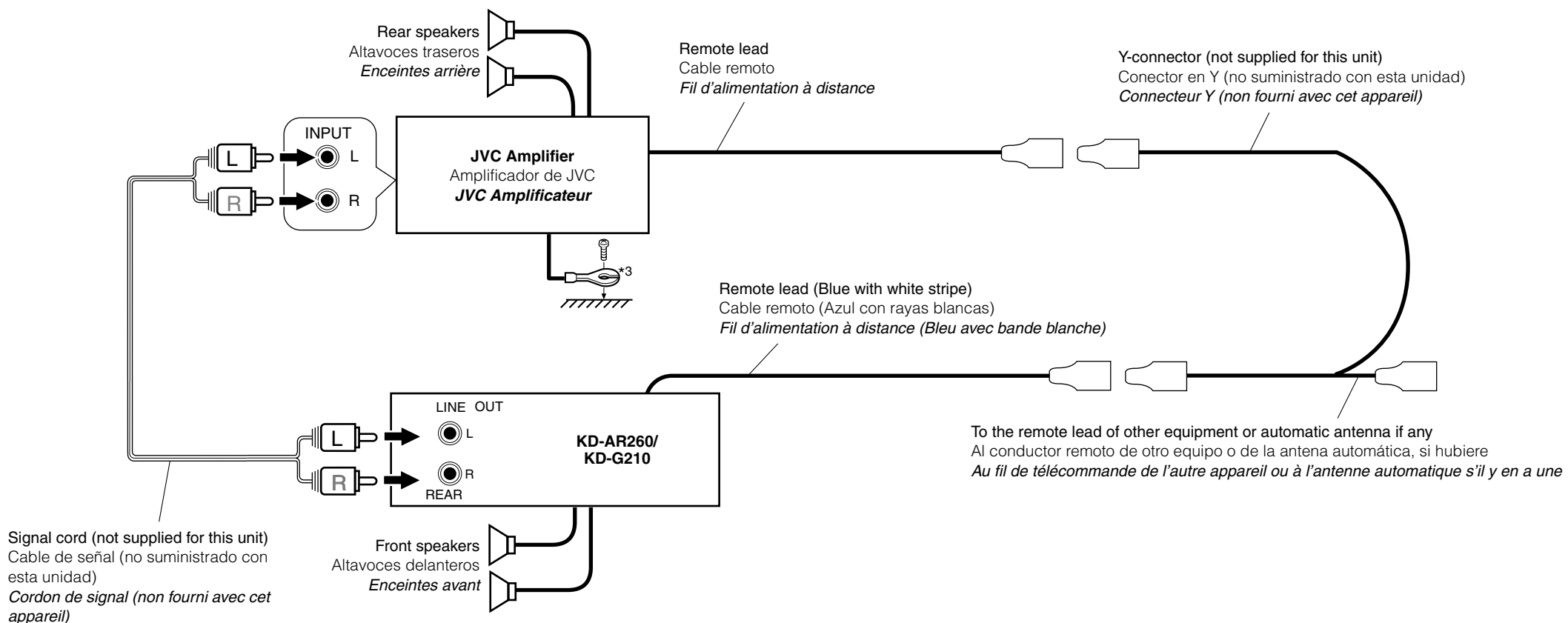

\*3 Firmly attach the ground wire to the metallic body or to the chassis of the car—to the place not coated with paint (if coated with paint, remove the paint before attaching the wire). Failure to do so may cause damage to the unit.

\*3 Fije firmemente el cable de tierra a la carrocería metálica o al chasis—a un lugar no cubierto con pintura (si está cubierto con pintura, quítela antes de fijar el cable). De lo contrario, se podrían producir daños en la unidad.

\*3 Attachez solidement le fil de mise à la masse au châssis métallique de la voiture—à un endroit qui n'est pas recouvert de peinture (s'il est recouvert de peinture, enlevez d'abord la peinture avant d'attacher le fil). L'appareil peut être endommagé si cela n'est pas fait correctement.

**PRECAUTIONS on power supply and speaker connections:**

- **DO NOT** connect the speaker leads of the power cord to the car battery; otherwise, the unit will be seriously damaged.
- **BEFORE** connecting the speaker leads of the power cord to the speakers, check the speaker wiring in your car.

**PRECAUCIONES sobre las conexiones de la fuente de alimentación y de los altavoces:**

- **NO** conecte los conductores de altavoz del cable de alimentación a la batería de automóvil, pues podrían producirse graves daños en la unidad.
- **ANTES** de conectar a los altavoces los conductores de altavoz del cable de alimentación, verifique el conexionado de altavoz de su automóvil.

**PRECAUTIONS sur l'alimentation et la connexion des enceintes:**

- **NE CONNECTEZ PAS** les fils d'enceintes du cordon d'alimentation à la batterie; sinon, l'appareil serait sérieusement endommagé.
- **AVANT** de connecter les fils d'enceintes du cordon d'alimentation aux enceintes, vérifiez le câblage des enceintes de votre voiture.

